

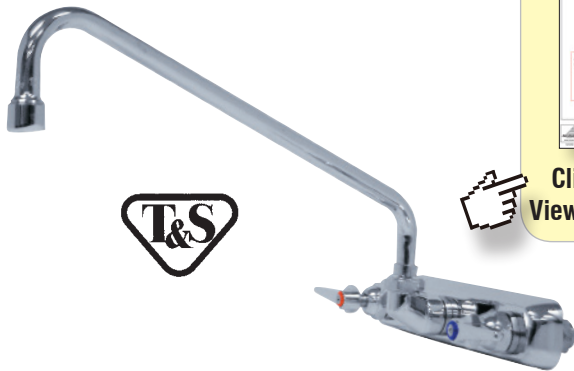

K-111 14" T&S SWING SPOUT SPLASH MOUNT FAUCET

Conforms To NSF 61/9 Lead Free Requirements



Click This Link To View Assembly Sheet

Item #: _____ Qty #: _____
 Model #: _____
 Project #: _____

FEATURES:

- 14" swing spout.
- 8" O.C. water supply.
- Quarter-turn wedge style handles.
- Colored hot & cold Indexes.
- 1.0 GPM/3.8 LPM Aerator. 60 PSI.

MATERIAL:

- Brass chrome plated body & spout.
- Chrome plated handles.

FAUCET AERATOR CONFORM TO
 ASTM.A112.18.1M • 1.0 GPM/3.8 LP
 THREAD: 55/64 - 27 FEMALE

Options & Accessories

Splash Mount Faucet
 Mounting Kit

K-06



Wrist Handles For Existing
 K-111 Faucet

*Can Only Be Used On Faucets Purchased After January
 2016. For Older Faucets, Consult Customer Service.

K-416-LU (Set of 2)



DIMENSIONS and SPECIFICATIONS

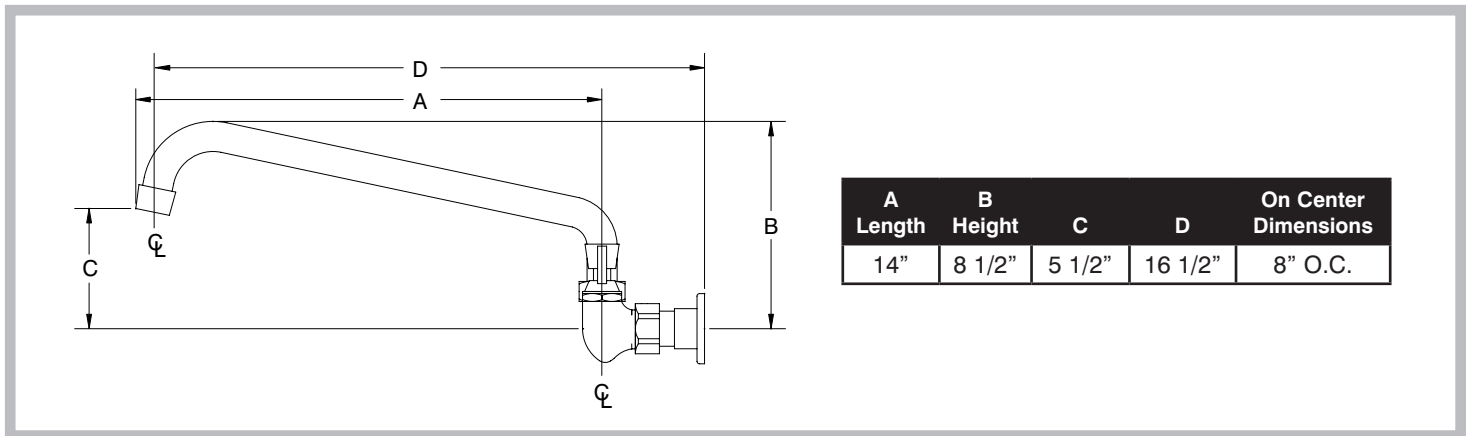

⚠ WARNING:

Faucet(s) on this page may expose you to chemicals, including lead, that are known to the State of California to cause cancer or birth defects or other reproductive harm. For more Info., visit www.p65warnings.ca.gov.



Customer Service Available To Assist You **1-800-645-3166** 8:30 am - 7:00 pm E.S.T.

For Orders & Customer Service:
 Email: customer@advancetabco.com or Fax: 631-242-6900

For Smart Fabrication™ Quotes:
 Email: smartfab@advancetabco.com or Fax: 631-586-2933