

T66T035-▲LHP

Submitted Model No.: _____

Specific Features: _____

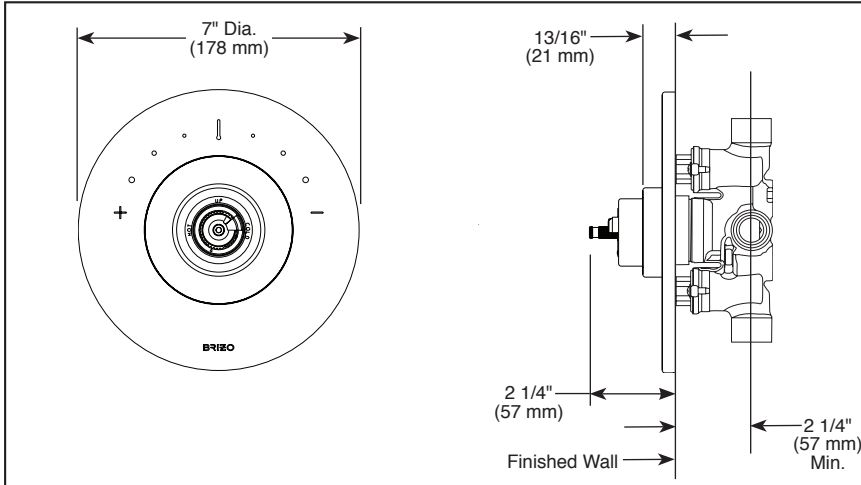

HL6632-▲ Lever Handle

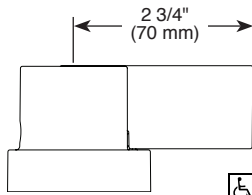

HL6633-▲ T-Lever Handle

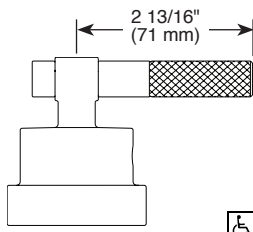

HL6634-▲ Industrial Lever Handle

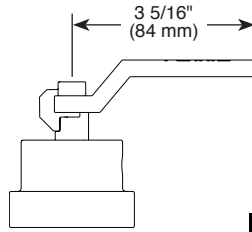

HL6639-▲ Wire Handle

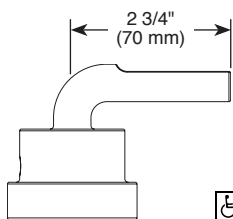

HW6632-▲ Wheel Handle

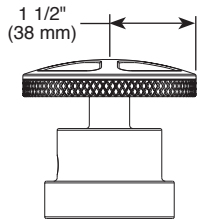

RP72604 Available Extension Kit

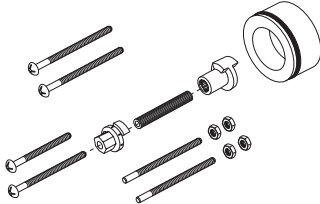

*Depending on the location of valve within the wall and wall thickness an optional extension kit (RP72604) can provide an additional 1 3/4" of wall thickness.

▲ Designate finish suffix

Brizo Kitchen & Bath reserves the right (1) to make changes in specifications and materials, and (2) to change or discontinue models, both without notice or obligation. Dimensions are for reference only. See current full-line price book or www.brizo.com for finish options and product availability.

BRIZO®

SENSORI® CUSTOM SHOWER TRIM

- Litze® Collection
- Thermostatic Control Trim

FEATURES:

- Sensori® Thermostatic Control

STANDARD SPECIFICATIONS

- Must also order R66000-WS rough valve body
- Includes Sensori® thermostatic cartridge
- Handle controls temperature only; must be used with one or more Sensori® volume controls
- Field adjustable to limit rotation into hot water zone
- All parts are replaceable from the front of the valve
- Adjusts for up to 5/8" wall thickness. Optional extension kit (RP72604) available

WARRANTY

- Parts and Finish - Lifetime limited warranty; or for commercial purchasers, 10 years for multi-family residential (apartments and condominiums) and 5 years for all other commercial uses, in each case from the date of purchase.
- Electronic Parts and Batteries (if applicable) - 5 years from the date of purchase; or for commercial purchasers, 1 year from the date of purchase. No warranty is provided on batteries.

COMPLETE VALVE COMPLIES WITH:

- ASME A112.18.1 / CSA B125.1
- ♿ Indicates compliance to ICC/ANSI A117.1



Brizo Kitchen & Bath Company

Indianapolis, Indiana 46280

A Division of Masco Corporation of Indiana

© 2020 Brizo Kitchen & Bath Company