

SAFE. ACCESSIBLE.
BATHING SOLUTIONS.

UPGRADE to solid surface

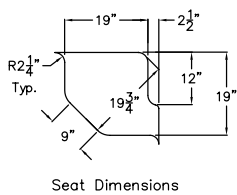

TOP VIEW

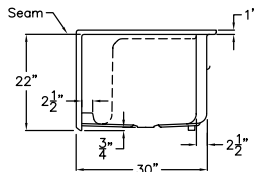
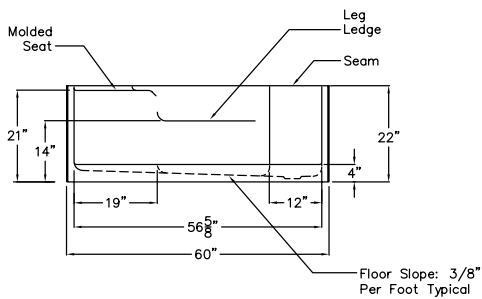
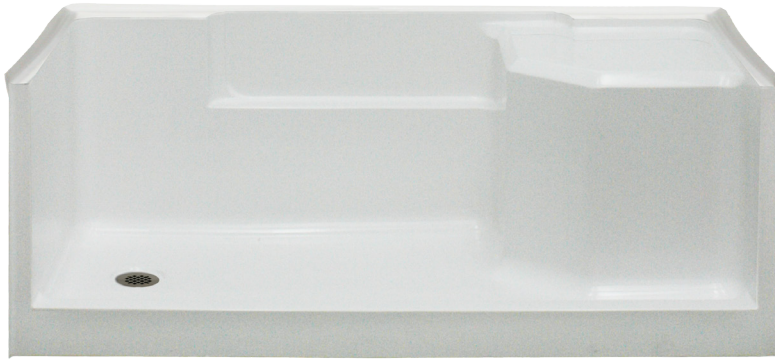
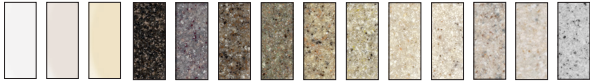
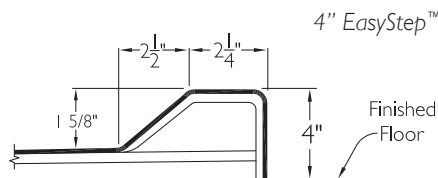
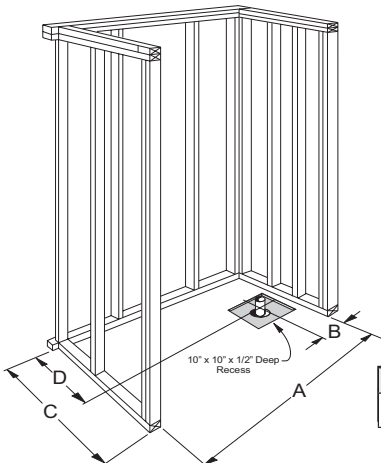
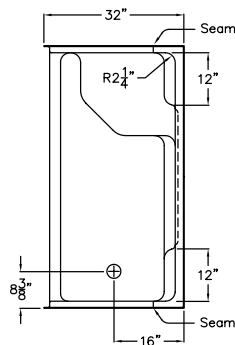

A	B	C	D
60 1/4"	8 7/16"	32"	16"

MyPlace™ AcrylX™ shower bases

MPB 3260 SH 4.0

OUTER DIMENSION	60" x 32" x 22"
THRESHOLD	4" EasyStep™
DRAIN	Left or Right
HANDED	Seat
SHIPPING WEIGHT	151
LOAD FACTOR	0.25
TRUCK LOAD FACTOR	0.25



EasyStep™
Threshold



Solid Surface
Finish



AcrylX™
Finish

NOTES

CODES code compliant with IPC, UPC, and ANSI Z 124.2 only.

RAPID SHIP All shower bases are in stock for rapid shipment - ships in four business days.

WARRANTY All shower bases are offered with an unprecedented lifetime limited warranty.



THE PRAXIS COMPANIES | praxiscompanies.com
customer service 800.443.7269

Due to the nature of the materials, dimensions may vary +/- 0.5".