

Tubular Plastic

Innovator® 590

For most tubs 14" - 16" high

**1.5" Tubular Plastic Bath Wastes
Slip-Joint Assembly
Now Coarse Thread**

SPECIFICATIONS

FEATURES:

- Eliminates all screws
- Eliminates leaks due to loose overflow attachment
- Eliminates dual inventory of one- and two-hole overflow plates; saves time on installation

APPROVALS:

- Manufactured in compliance with ASME A112.18.2-2005/CSA B125.2-2005.
- Manufactured in compliance with ASTM F 409-2002 and NSF/ANSI 14-2007.

PATENTS:

- U.S. Pat. Numbers 4,457,030; 4,720,877; 5,758,368; 5,890,241; 6,637,050; 6,675,406; 7,127,752; and Patents Pending
- Canadian Patent Number 2,437,448
- Mexican Patent Numbers PA/a/2003007344; PA/a/2005002784

THREAD SIZE (Strainer Body and Drain Elbow):

- 1.865" - 11.5 NPSM (Coarse Thread)

PIPING: PVC ABS

ROUGH-IN (RI's) and STOPPER/FACEPLATE (SF's)

STOPPER/FACEPLATE'S (example: 900-PPSF-0-CP)

Made up of the overflow plate and stopper assembly; NO strainer body.
(See next page for available stopper assemblies.)

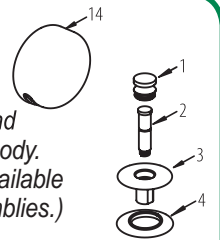

ROUGH-IN'S (example: 590-PPRI-PVC-CP)

Made up of all parts, including strainer body, except the overflow plate and stopper assembly

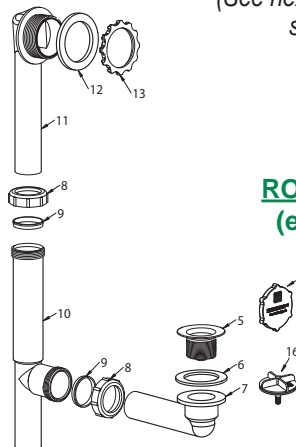

Snap-on
overflow plate.
No screws



ADA

PRESFLO® (PF)
Foot Actuated (FA) only

See price list for complete item numbers and available options.

When ordering, please specify complete item number and any applicable option codes.



For More Information Contact:
WATCO Manufacturing Company
1220 South Powell Road
Independence, MO 64057-2724
Ph. 816-796-3900 • FAX 816-796-0875
www.watcomfg.com

590 Series Parts List

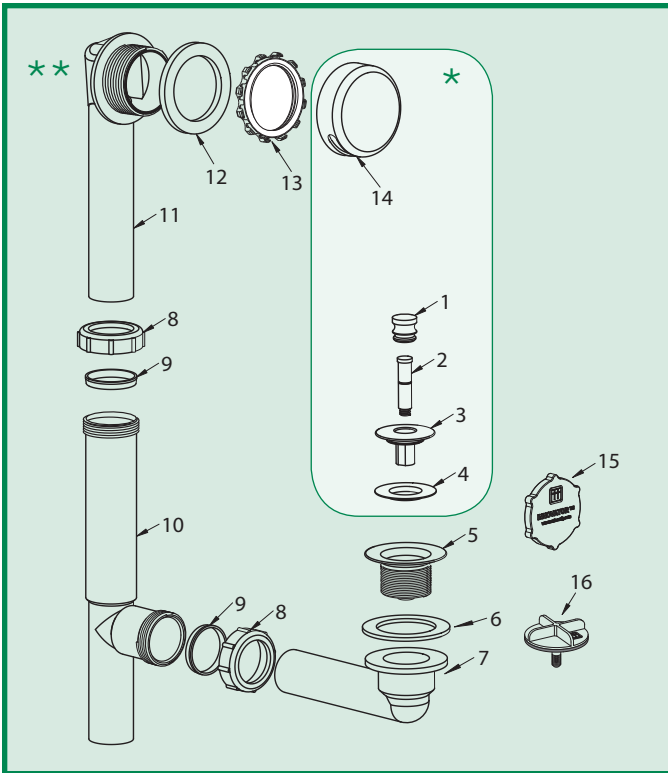



** RI: (example: 590-PPRI) Parts #5 thru #13, #15 and #16

Item Part # Description

1. 01010CP.....Knob, Brass
2. 11510Friction Ring (11505) and Post (11532)
3. 01013CP.....Stopper, Brass
4. 11507Seal, 1 1/16" dia.
5. 01016CP.....Strainer Body, Brass, 1 1/2" – 1 1/2"
6. 10696Drain Ell Washer, 1.5", gray
7. 11028.....Drain Ell, Tubular ABS, Coarse Thread
14028Drain Ell, Tubular PVC, Coarse Thread
8. 11580.....Slip Joint Nut, ABS
11581Slip Joint Nut, PVC
9. 11583.....Slip Joint Polywasher
10. 11000.....Tee, Tubular ABS
14000Tee, Tubular PVC
11. 11019Innovator® Overflow Ell, Tubular ABS
14019.....Innovator® Overflow Ell, Tubular PVC
12. 10675Overflow Ell Washer, Foam
13. 11121Star Retainer Nut for Innovator®
14. 01004CPInnovator® Overflow Plate
15. 11114Innovator® Test Cap
16. 11575.....Test Plug w/O-Ring-type Gasket

* SF: (example: 900-PPSF) Parts #1 thru #4, and #14

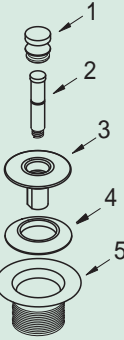
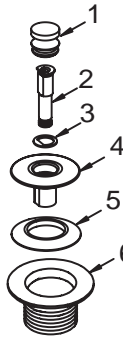
OPTIONAL TUB CLOSURES FOR 590-SERIES BATH WASTES (PUSH PULL® ALSO SHOWN ABOVE)

 PUSH PULL® Coarse Thread	 LIFT & TURN Coarse Thread	 PRESFLO® Coarse Thread	 FOOT ACTUATED Coarse Thread
<ol style="list-style-type: none"> 1. 01010CP 01010__* 2. 11510 3. 01013CP 01013__* 4. 11507 5. 01016CP 01016__* 	<ol style="list-style-type: none"> 1. 01010CP 01010__* 2. 11079 3. 11088 4. 11290CP 01013__* 5. 11507 6. 11492CP 01016__* 	<ol style="list-style-type: none"> 1. 11145CP 11145__* 2. 11132 3. 11060CP 11060__* 4. 96039: Suction Cup for removing stopper 	<ol style="list-style-type: none"> 1. 38412CP 38412__* 2. 11492CP 01016__*
U.S. Pat. No. 4,720,877	U.S. Pat. No. 5,758,368	U.S. Pat. No. 4,457,030	

*If finish other than Chrome is desired, please use this part number and indicate desired finish.

Finishes Available in the 590 Series:

Tub Closures:	PUSH PULL®	LIFT & TURN	PRESFLO®	FOOT ACT.
CP - Chrome Plated	•	•	•	•
AB - Antique Brass				
AP - Aged Pewter	•	•	•	
BB - Brushed Bronze	•	•	•	
BN - Brushed Nickel	•	•	•	•
BO - Bone	•	•		
BS - Biscuit	•	•		
BZ - Oil-Rubbed Bronze	•	•	•	•
CB - Chrome Brushed	•	•	•	
NP - Nickel Polished	•	•	•	•
PB - Polished Brass	•	•	•	•
PN - Pearl Nickel	•	•	•	
WH- White	•	•		
WI - Wrought Iron	•	•	•	

Roughing-In Dimensions

